

# SPAD XIII Flight Simulator

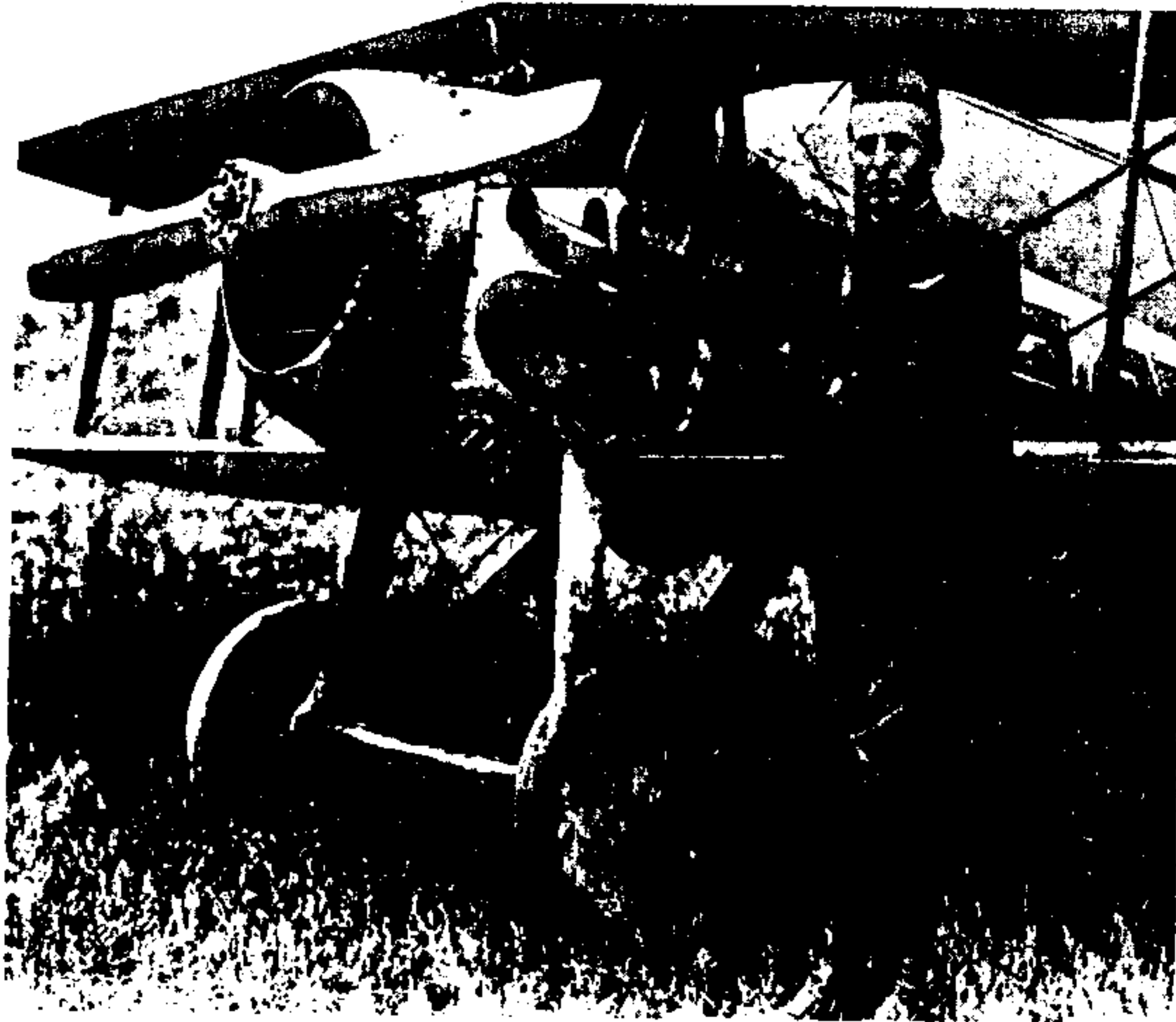

Frank Luke

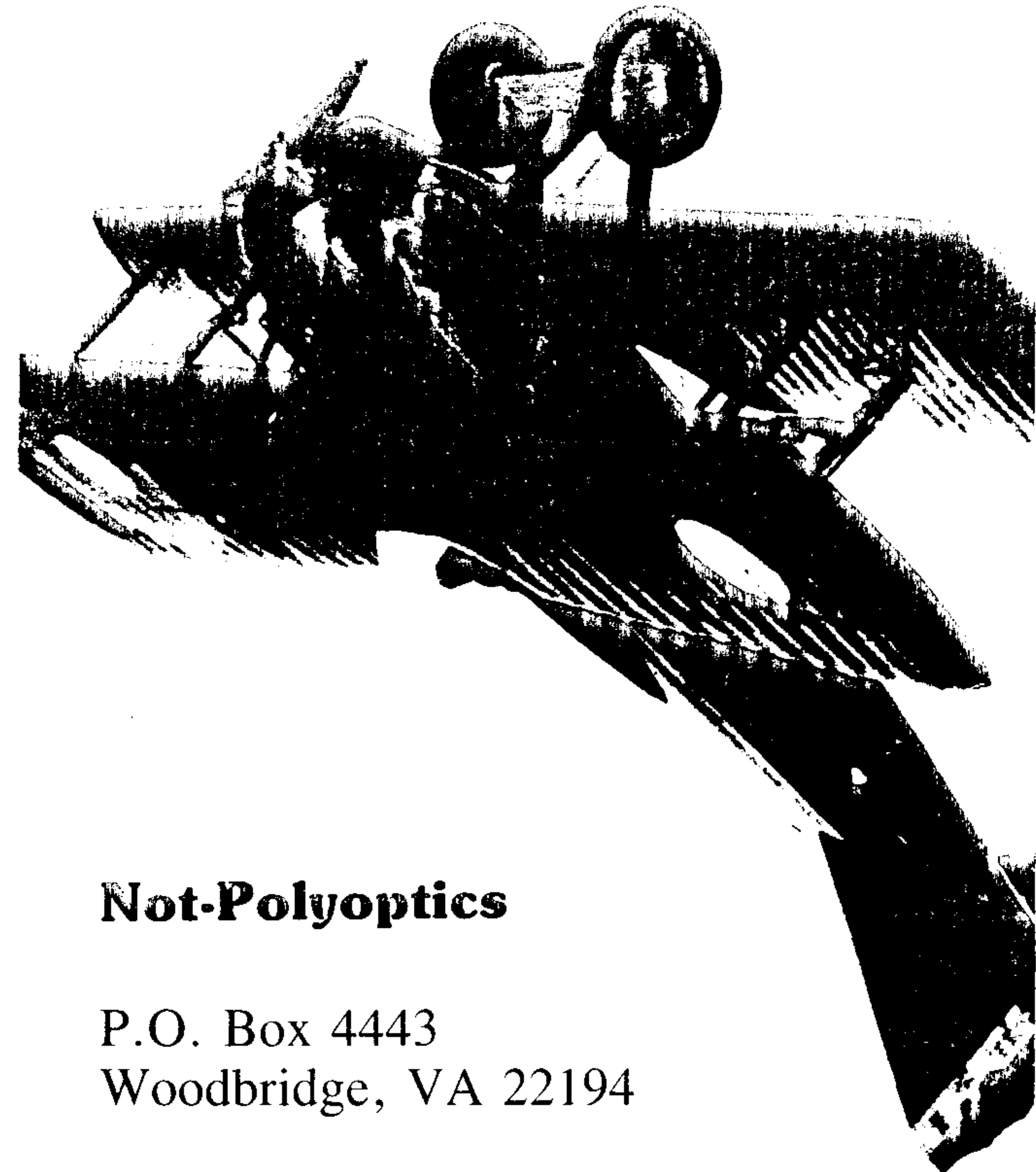

**Not-Polyoptics**

P.O. Box 4443  
Woodbridge, VA 22194

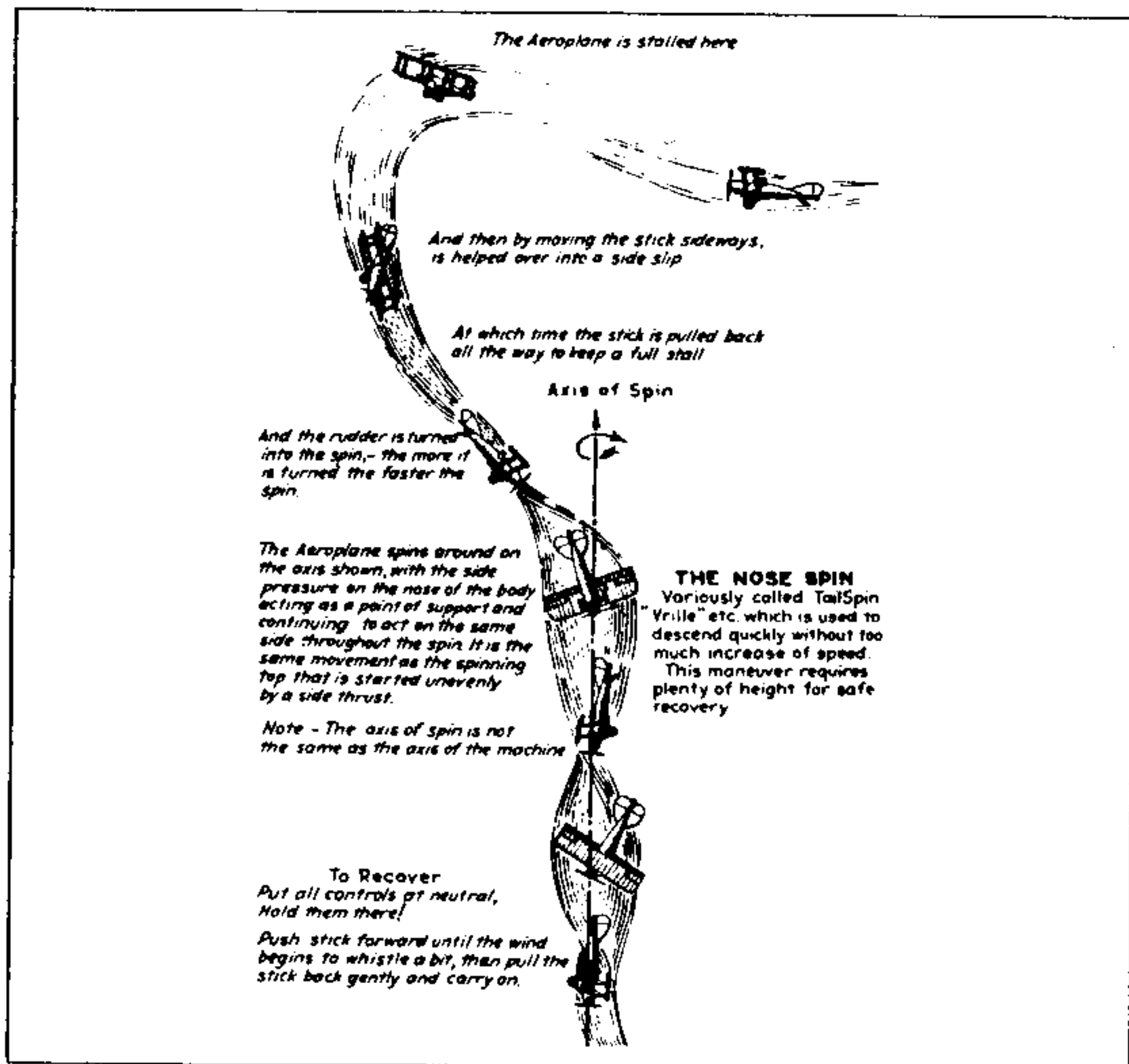

NOT POLYOPTICS

XIII

NOT  
POLYOPTICS

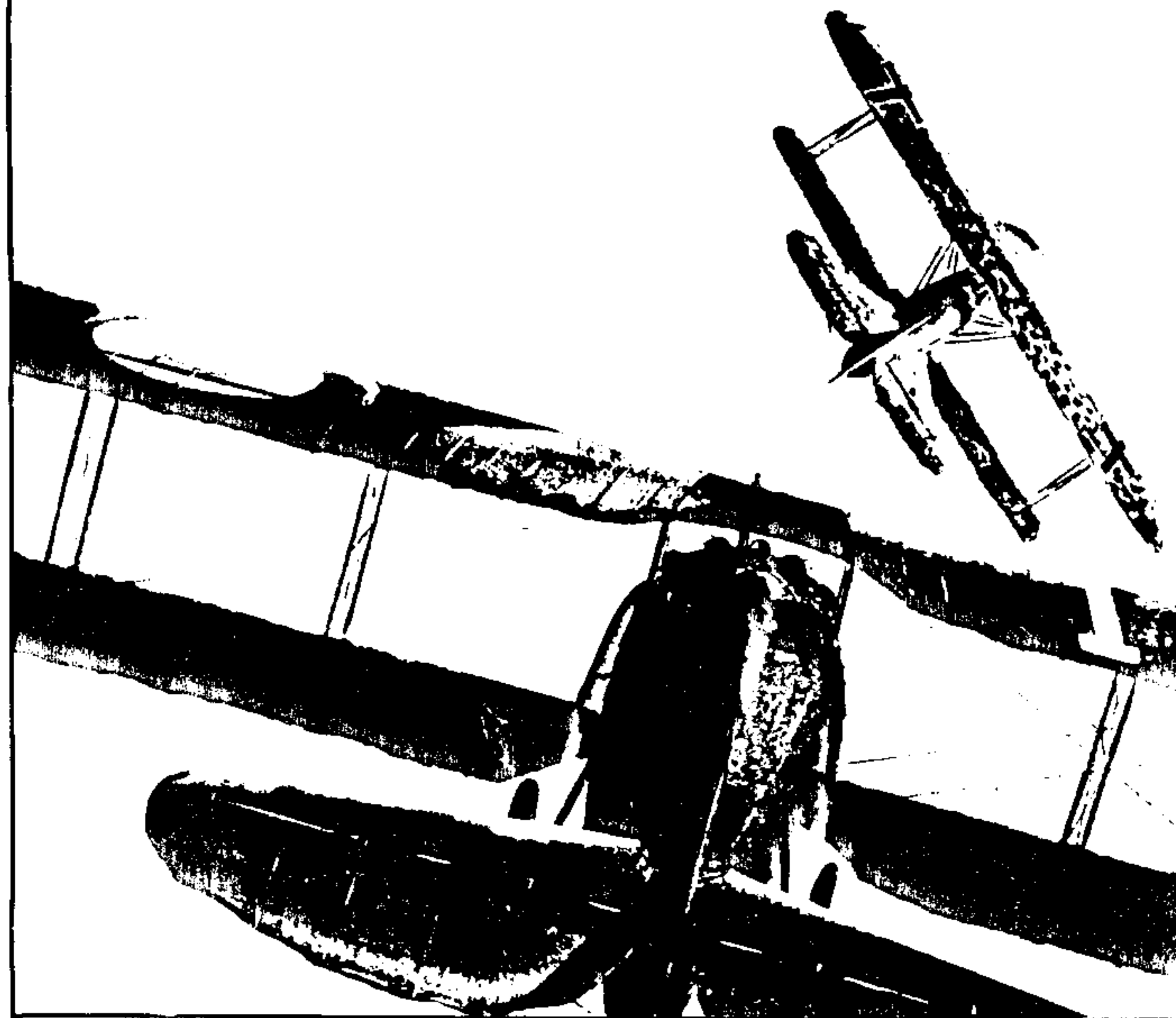

**Bells and Whistles-**A high beep is generated by your tires when they are just touching the ground (landing or taking off). Another beep is generated when enemy fire hits your plane; this doesn't necessarily mean you've been damaged - a bullet can pass through the fabric of your plane without really damaging it.

A lower buzz is generated when the Spad stalls, representing the vibration of the wood and fabric plane as it is stressed.



©1987 by Not-Polyoptics  
All Rights Reserved

# SPAD XIII Flight Simulator

*Mark 2*

Addendum



*Spad XII Flight Simulator, Mark 2* is a considerably expanded version of the program, adding many new features and improving graphics and flight algorithms. In all cases, this addendum is an addition to, not a substitute or correction of the original *Spad XIII* Instruction Manual.

### Extended Keyboard - (modifies Section B3:page 5)

Five new keys have been added in *Mark 2*. You may wish to write them into the Keyboard Template (Page 10).

#### Left side:



This key is for hard forward stick, useful for power dives and for flying upside down. To fly upside down climb to a safe altitude, get air speed up to 150 by diving at full throttle, do a half roll with the **A** (full left) or **F** (full right) key, and press the **T** key continuously. You must keep the stick pressed hard forward or it will spoil the maneuver. Note: outside loops were not possible until specialized acrobatic planes were developed after the war.

#### Right side:



This is a right side fire key, which enables you to use the left side aileron controls and fire simultaneously. The fire button on Joystick 2 will now fire the machine guns, which means it is possible to maneuver with Joystick 1 and shoot with Joystick 2 (or the **Y** key) at the same time.



The 'Eye' key gives a removed view of your Spad and its environs, from 300 feet south and slightly above its present position. With this key you can watch yourself putting the plane through its paces, landing, or get a unique spectator seat for acrobatics. You can maneuver and bomb from this view, but not fire, which makes it a questionable tactic for dogfights.



This key pans continuously through all of the Spad-centered views. This is useful for searching the skies for enemy planes. To get out of the panning mode press any other view key. You can maneuver and bomb in this mode, and fire your guns when the Front Instrument Panel is visible.



The 'Move' key gives you the ability to instantly transport your Spad to various strategic locations of the Operational Area. Choose between the Eiffel Tower, the enemy airfield, your airfield, or the trenches (just west of the balloons). A menu will appear: just press the number of the area you wish to go to. You can thus get quickly to the action (or away from it.) The Move key won't affect the Spad's other parameters and it doesn't function if the Red Baron is in your vicinity. The Move key also can be used as a Pause key while the Menu is onscreen.

### Improvement in Flight Algorithms

In *Spad XIII, Mark 2*, the flight characteristics of the Spad have been modified slightly to improve realism. The Spad XIII had a slightly positive roll stability, and *Mark 2* reflects this - the Spad will always have a tendency to roll back to a level position while in a bank. This means that, except for the prevailing 10 mph westerly wind, you can fly in a perfectly straight line and don't have to worry about small roll angles.

Other slight improvements have been made to *Mark 2*, so that it has a slightly different feel than *Mark 1*, but all instructions in the Manual are still completely correct.

### Red Baron

*Mark 2* introduces the Red Baron, an ace enemy fighter pilot flying a Fokker triplane in your sector. These Fokker triplanes have three wings (instead of two), and its machine guns (like the Spad's) point forward through the propeller. The Fokker pilots are expert shots, and fly a plane that is in some ways better than the Spad. Among their number is the famed Baron Von Richtofen, who you may have the bad luck to encounter. These triplanes generally conform to the strategy of getting on your tail to shoot you down, and are relentless in their pursuit. At the title screen you are asked 'RED BARON(Y/N)'. Press **Y** to include Fokker pursuit planes or **N** to not include them. Novices are discouraged from engaging these proficient flyers.

One Red Baron is generated at the beginning of the program and every time you land to refuel and rearm. Thus, if you find a Red Baron and shoot him down, you don't have to worry about another one until you land again at your field.

Your Spad XIII is slightly faster than a Fokker so you can outrun it by going to full throttle and diving full stick forward; of course, you need plenty of altitude to do this. Doing an Immelmann followed immediately by a Split-S or another Immelman can reverse your positions and give you the upper hand. Whatever you do, keep changing your direction to stay out of his fire. Sometimes you will be trapped on the ground at your airfield. When this happens, wait until the triplane passes overhead and then take off as quickly as possible. He will circle to get back to you and will be vulnerable until he gets back on your tail. Since you will be at a low altitude, there will be little chance to outrun him, so you'll have to fight. Remember, the 'Move' key does not work when the Red Baron is near.

### End of Game - (modifies Section B8d:page 16)

In *Mark 2*, it is possible to restart the program after it has ended. After the game has ended, the program prompts you with 'S TO START E TO END'. Press **S** to play again or **E** to return to the TI Main Title Screen.

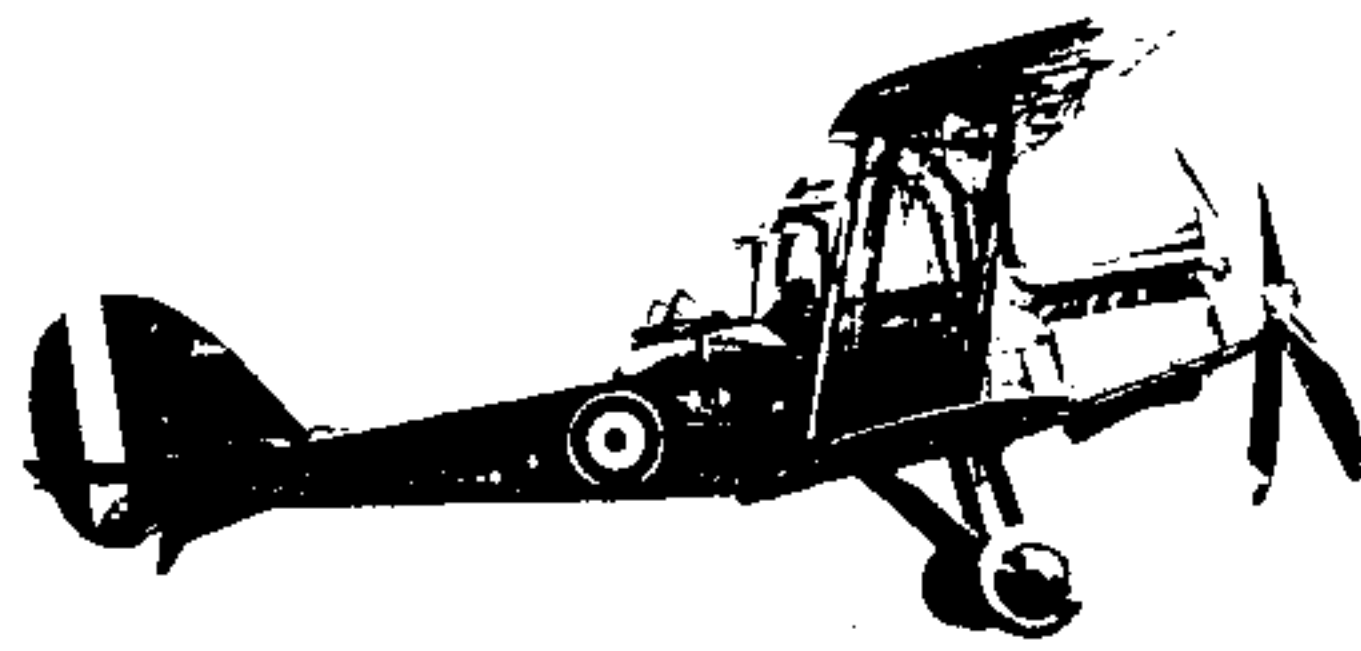

## A. HISTORY

Barely ten years after the Wright Brothers pioneered motorized flight in a fragile structure of canvas, wires, and wood, men had adapted their invention to the needs of war. These new machines were much improved - stronger, faster, and more dependable - but they still bore a great resemblance to their prototype. As soon as it was generally realized that these aerial 'birdcages' made excellent instruments of war, governments around the world were ready to spend more and more money on them, and companies such as Sopwith, Nieuport, and Fokker used that money to progressively improve designs.

World War I was the first war to use many of the machines and methods we associate with modern war. It was also an unspeakable, frightful, bloody mess serving mainly to lay waste to European civilization and decimating its male population. In contrast, however, to the horrors of the trenches, the Air War was clean, somewhat chivalrous, and made good copy. From the newspapers of the time sprang the Air Ace, the ultimate swashbuckler, capable of distracting the civilian public from the pointless stalemate. Although they couldn't quite live up to their press, the flyers were daredevils who often risked their lives and whose exploits, truthfully recounted, were very exciting.

S.P.A.D., the *Société Pour Aviation et ses Dérives*, a French company run by the famous aviator Louis Blériot, shared in the profits spawned by World War I. The Spad XIII, an improved model of the earlier VII, was introduced in April 1917. It was a very stable plane with a more powerful engine and an extra Vickers machine gun. In the hands of the great aces of the time, it reversed the balance of air power once again and gave superiority to the Allies. It was an excellent gun platform, and exceptionally durable, though the engine tended to break down. There were no American pursuit planes used in WWI, and the American aces Rickenbacker and Luke preferred to use Spads when they could get them.

## B. FLIGHT SIMULATOR

*Spad XIII Flight Simulator* is machine language program for the TI 99/4A computer. In order to run it, you must have an Extended BASIC cartridge, the 32K Memory Expansion, and a disk drive. It is auto-loading from Extended BASIC, which means that the program will self load if it is in Disk Drive 1 when Extended BASIC is initiated. The program will not load from Disk Drive 2. If Extended BASIC is already initiated, type in 'RUN DSK1.LOAD' and press **ENTER**. The message 'SPAD XIII - LOADING, PLEASE WAIT...' appears on the screen.

To see the *Spad XIII* title screen type 'RUN DSK1.SPADPIC' and press **ENTER**. **DO NOT REMOVE THE WRITE PROTECT TAB FROM THIS DISK. TURNING THE COMPUTER ON WITH A DISK IN THE DRIVE CAN DAMAGE DATA ON THE DISK.**

### 1. How to Fly

The following is a limited introduction to flight. Basic concepts will be discussed in order to prepare for *Spad XIII*. However, controlling an airplane is not a simple task, and the reader is encouraged to follow up this introduction with further reading on the subject. We recommend *Stick and Rudder* by W. Langewiesche (McGraw-Hill, 1944) for a comprehensive yet entertaining book for beginners.

An airplane in flight is subject to four principal forces. These are lift, drag, weight, and thrust. Lift is made by the motion of the wings through air and pushes in the direction of the top of the plane, generally up. Weight counters this force, pulling downward toward the earth. Thrust is the force generated by your engine turning a propeller; it acts to push the plane forward. Drag counters this force - it is the air resistance friction that acts in the direction opposite the thrust and slows the plane.

A wing works through channeling the air that passes by it in specific ways that generate lift. Contrary to popular belief, the downwash produced by the wing is more important in generating lift than the pressure imbalance produced as air flows around the wing. Lift can be increased by increasing airspeed or by increasing the angle of attack (the angle at which the wing meets the air). When the angle of attack exceeds 18 degrees or thereabouts, the downwash of the wing is dissipated by increasing turbulence and a stall, the condition in which the wing loses its power to lift, occurs.

Because the airplane is made up of many complicated surfaces and has an uneven distribution of weight, the behavior of the plane can not be simply described. However, some general characteristics apply to most planes, and the Spad XIII in particular. The heaviest part of the plane is

the engine, and thus the plane's center of gravity is in front of the center of lift. This means that counterbalancing of forces on the plane will eventually bring you back into stable, level flight. If you slow down, the nose of the plane will drop, and you will gain speed as you lose altitude. Conversely, if you increase speed, your nose will rise and the increased angle of attack will slow the plane down. Thus, if your wings are parallel to the ground and you have sufficient airspeed, you needn't worry about losing control.

Turning the airplane always involves banking the wings. On each wing there is a control surface which allows you to independently change the nature of the wing. This increases the lift on one wing and decrease the lift on the other, causing one wing to rise and the other to drop. When this happens, a number of things also happen, all of which contribute to the turning of the plane. The principal cause is that the normally vertical component of lift has been shifted horizontally, and thus the plane is lifted sideways, i.e. it turns. As the plane banks, however, and the total lift is not directed upward, the nose will drop and you will lose altitude.

How the control surfaces of the plane affect the flow of air will be discussed in more detail below.

## 2. Control of the Spad

The flight of a plane occurs, obviously, in three dimensions. In order to better describe the movement of the plane along these three axes, the terms yaw, pitch and roll are used. Yaw is rotation around the vertical axis of the plane, rotating left and right. Pitch is rotation around the axis that passes through the wings, moving the nose up and down. And Roll is rotation around the axis that passes through the fuselage, moving the wings up and down.

### a) Lateral Controls - Roll and Yaw

As discussed above, turning the plane involves changing the degree of Roll in order to change the Yaw of the craft. The ailerons, flaps on the trailing edge of the wings which can be raised and lowered, are used to do this. They are controlled by means of the stick. When the stick is moved to the right, the right aileron goes up and the left aileron goes down, resulting in a right turn. When the stick is moved to the left, the opposite happens.

The rudder, though theoretically a direct way to control the Yaw, should only be used in conjunction with the ailerons. Turning the plane with the rudder alone is slow and the increased drag will cause the plane to lose altitude.

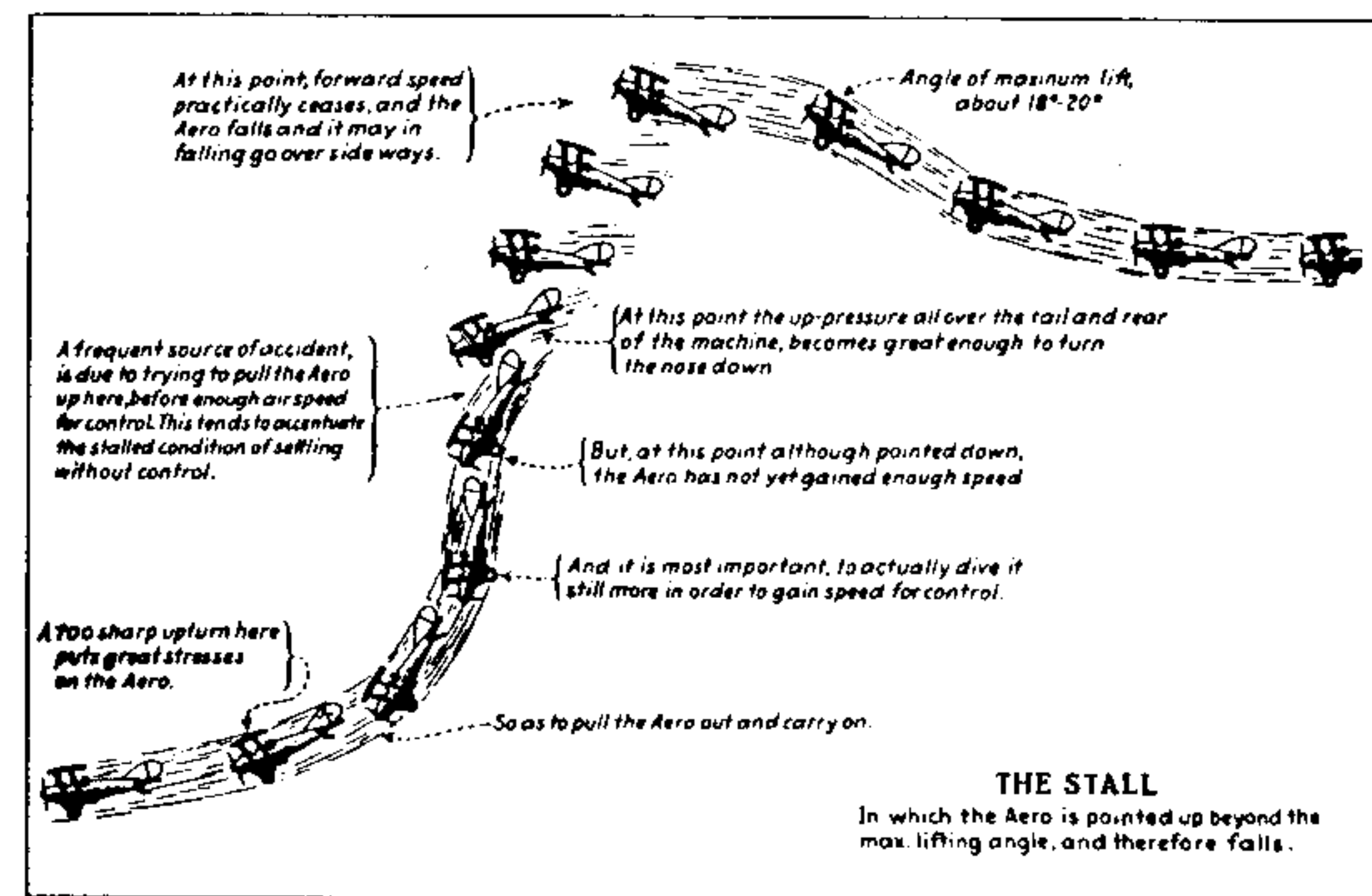

### b) Pitch Controls

The current airspeed and the position of the nose are interrelated phenomena; thus the controls you have to change the pitch of the airplane, the throttle and the elevator, can control either the airspeed or the nose's position. When the throttle is raised, increasing the RPM of the engine and the speed of the propeller, the nose will go up and the altitude will increase. Contrary to expectations, unless you hold the nose down using the elevator, speed will decrease. Lowering the throttle causes the plane to lose altitude and thus speed up.

The elevator is also controlled with the stick. Pushing forward on the stick causes the airplane to drop its nose, lose altitude, and gain speed. Pulling back on the stick causes the airplane to raise its nose, gain altitude, and lose speed. Altitude gains due to elevator effects are short-lived because of the loss of airspeed, which causes the nose to drop (as long as the stick is not still being pulled back). The best way to stall an airplane is to pull back on the stick until the airplane's speed is less than its stated stalling speed.

### 3. Keyboard Interface

The *Spad XIII Flight Simulator* is controlled either entirely from the keyboard or from the keyboard with Joystick 1 substituting for the stick movement keys and fire button. Two commands may be input at one time, one from the left side of the keyboard (or the joystick) and one from right side. Press the key until you see the appropriate reaction on the screen.

The stick movement keys are **E-S-D-X-W-R-Z-C** as illustrated in Figure 1. **A** is strong left, **F** strong right, and **V** strong back stick for acrobatic moves (the joystick has no corresponding positions to accomplish these maneuvers). You will be able to see the stick move in response to your actions.

The view keys are **1-2-3-4-5-6**. They are also illustrated in the accompanying figure. You may change the view at any time, and for strategic purposes it is important to look around for enemy planes. The **U** key presents an unobstructed view from the front only. To restore the plane on the screen press any one of the view keys. Firing is possible only when the forward, instrument panel view is on the screen. If a view key is pressed continuously you can peek through the planes' wings and fuselage.

When you look up (view key **5**), forward is down on the screen. When you look down (view key **6**), forward is up. Picture the pilot actually looking up or down from his seat in the cockpit.

The throttle keys are **7-8-9-0** as illustrated below. **7** and **8** raise and lower the throttle in increments. **9** gives full throttle, and **0** stops the engine. (Even at 0, air pressure may keep the propeller moving and cause the engine to run.)

The rudder keys are **,** and **;**.

The fire key is **Q** (or Joystick 1's button). The fire key only works from a forward, instrument panel view. You can not fire the guns and move ailerons at the same time, but the rudder can be used for turning. **B** drops a bomb. For bombing, it doesn't matter which view you are seeing, but to see the bomb drop you must look out of the bottom. Altitude must be less than 1000 feet to see the bomb explode.

The kill program key **K** works only if you are safely on the ground. It will display the Final Score screen and end the game.

At any time, **FCTN +** (Quit) can be pressed to halt the simulator and return to the master title screen.

The alpha lock key must be up to use Joystick 1 for input.

### 4. Instrument Panel

In the *Spad XIII Flight Simulator*, the screen represents the view of the pilot sitting in the cockpit. In addition to the wings, struts, and guns of the plane, the view includes an instrument panel and the outside scenery. The instrument panel consists of four gauges and two mechanical devices. The gauges with their readout markings are illustrated in Figure 2.

The altitude gauge, on the left, is a barometric device corrected for relative altitude. It has two hands, one black and one white. The black hand indicates thousands of feet and the white hand indicates hundreds. The readings go from 0 to 1,000 feet and 0 to 20,000 feet. Thus if the gauge has the black hand pointing straight down and the white hand pointing at 3 o'clock, the plane is at altitude 10,250 feet.

The air speed gauge, on the right, has one hand and registers from 0 to 200 knots. If the airspeed drops below 40 knots a stall is likely.

The compass, on top, is a standard magnetic device corrected for the mass of the engine. North is up and East to the right.

The fuel gauge, on the bottom, reads full at about 10 o'clock and empty when pointing straight up. It moves counterclockwise.

The throttle is the handle below and to the left of the instrument panel. Top is 1200 RPM. It is pegged at 200 RPM although the throttle changes in increments of 100 RPM. Up increases throttle, down decreases.

The stick is located in the bottom center of the display. It moves to 9 different positions to indicate the appropriate action. Shorter means pulling the stick back, longer means pushing forward on the stick.

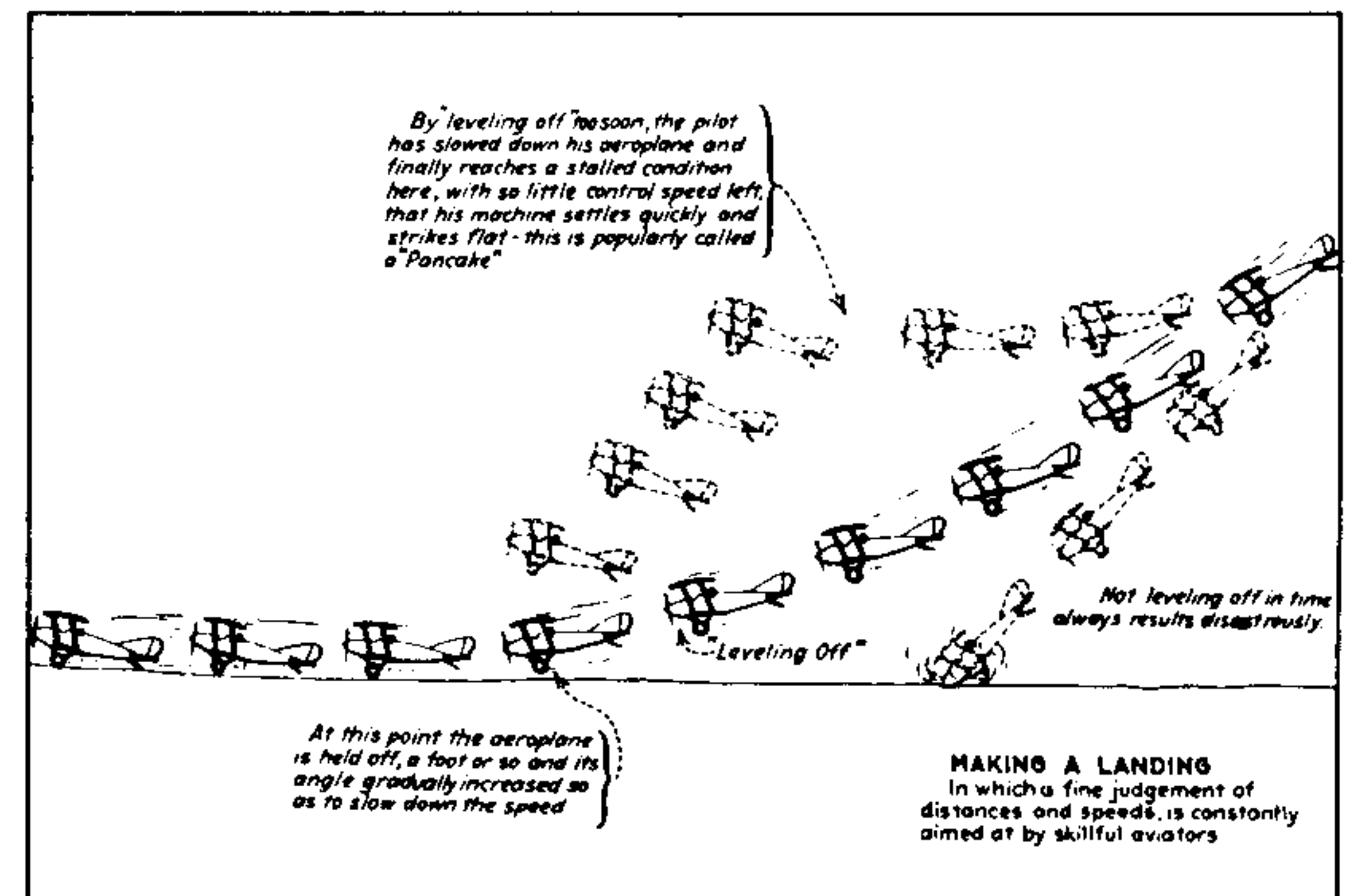

## 5. Objects on Ground and in Air

The scenery in the *Spad XIII Flight Simulator* is, of necessity, somewhat stylized, although full 3-D is always observed. The horizon is a dark green line with the white line of clouds always above and parallel to it. In the sky are scattered higher clouds - these are small white flecks until you get close to them, when they appear as parallel, white lines. The sun, in the Southeastern sky, is a yellow burst of lines.

### On the ground, there are:

- your plane's shadow - a dark green cross, always opposite the sun from you
- trees - dark green, at regular intervals
- your airfield - dark green parallel lines with one black hangar
- enemy airfields - has two hangars and a parked plane
- trenches - jagged dark yellow lines, run infinitely north-south
- Seine R. - dark blue, runs infinitely north-south
- Eiffel Tower - black multi-lined tower on rectangular park near Seine
- French villages - green multiple boxes with church steeple at center
- destroyed villages - as above but black
- hills - polygonal green shapes; may be faintly seen from a great distance

The skies are infested with Hunnish airships:

- German two-seaters - black; defended by observer machine gun;
  - emit smoke, fall, explode against earth when shot down
- observation balloons - black, cigar shapes;
  - destroyed like German two-seaters except defended by flak units on ground
- flak explosions - yellow/red bursts in the vicinity of balloons and enemy airfield

- Your bombs - black; explode against earth, destroy German hangers
  - explosions - red and yellow; may be seen if within 1000 ft;
  - damage to airships and hangars is indicated by white line of smoke

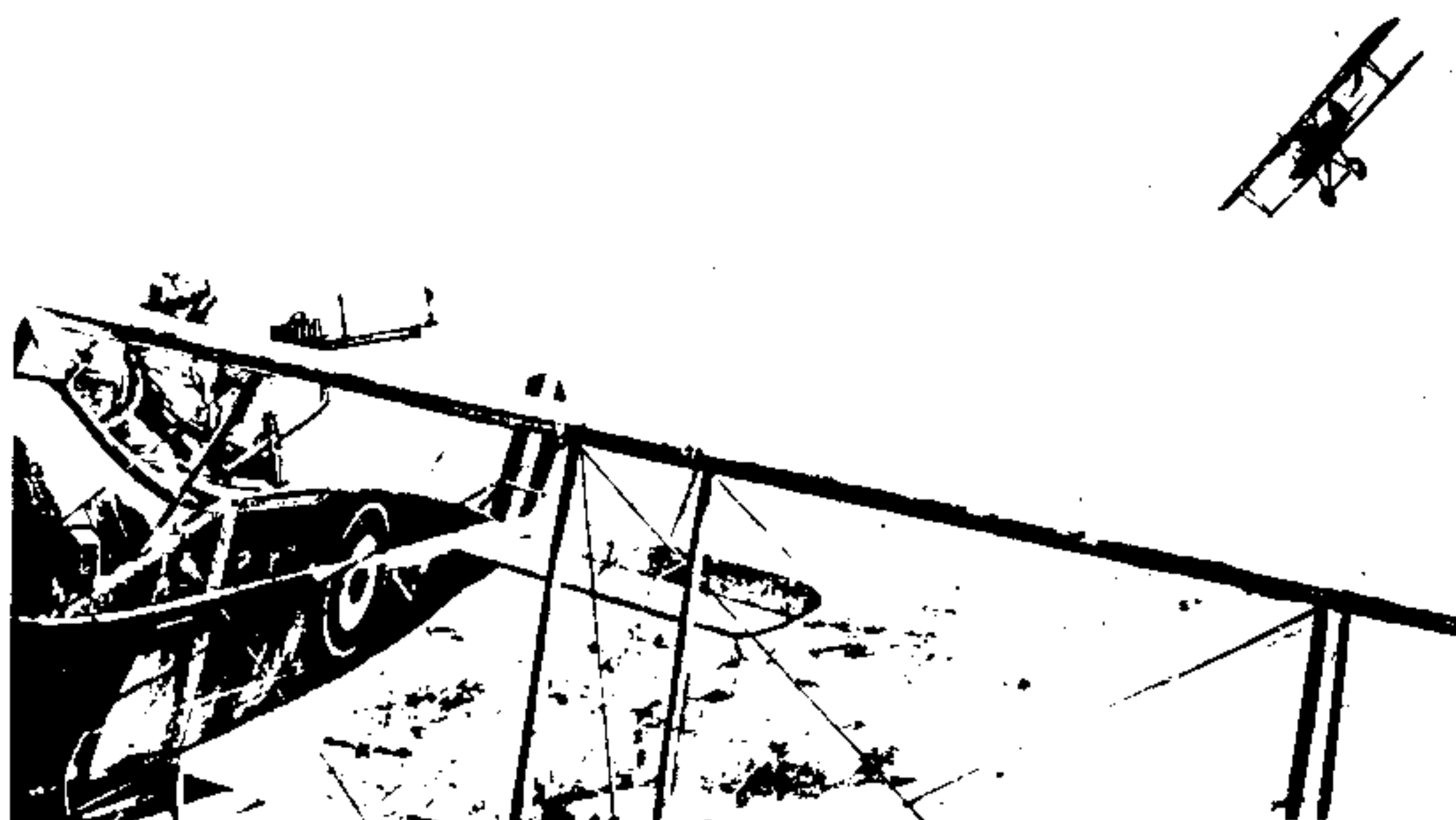

## 6. First Flight

### a) Take Off

To take off, press key **1** to get a front view with instruments. Apply full throttle by pressing the **9** key until you hear the motor rev. Watch the airspeed indicator dial move to show your increasing speed. When it reaches 100 knots (straight down), pull back on the stick (**X** or back on the joystick) until the screen stick moves, then let go. As you lift off, the runway will drop away. The altitude gauge will show your rising height. Depress the throttle a notch with **7** key for a controlled ascent. Shift to the rearward view by pressing the **4** key and you can see the airfield falling behind. Don't attempt any turns until you have attained at least 100 feet of altitude.

### b) Climbing

Look out your front view and notice that the dark green horizon line is below your gunsight. This means that you are climbing. The proper way to climb is by increasing throttle - the elevator is really only a way of pointing your nose for temporary gain or loss of altitude. If you raise your nose too much with the elevator, your airspeed will drop dramatically and you will stall. The proper use of throttle and elevators to control altitude is a difficult skill and will come only upon sufficient time in the air. Continue your ascent to 3000 feet.

### c) Cruising

Once you have reached 3000 feet, you will level off by lowering the throttle (key **7**) three notches to 800 RPM. Although the plane may oscillate a bit, eventually the gunsight (and top of tail) will line up with the horizon. The plane will be in level, straight flight at 120 knots.

### d) Turns

To turn, as discussed above, it is necessary to raise one wing and lower the other using the ailerons. Press the **S** key (or move the joystick to the left) until the screen stick moves to the left, and then release. The plane will begin to bank left. Notice the clouds are moving to the right as you change direction. Your nose will drop a bit from its previous position as you lose lift. Continue in this slow turn until you are headed south. Press the **D** key (joystick right) until the stick moves and level off. After a few moments you should see your airfield near the horizon it will appear only as a dark green spot.

### e) Descending and Landing

Use the ailerons to move the airfield to the center of the view, being careful not to let the plane bank too far right or left. The rudder can be used for fine adjustments, but remember using it comes with a penalty of lost airspeed. Lower the throttle four more notches and keep the field in your crosshairs as much as possible. Press the **U** key for an unobstructed view and the **1** key to return instruments. Lower the throttle if the near end of the airfield is below your crosshairs. As the airfield comes up, lower the throttle even more to keep



# SPAD XIII Instrument Panel

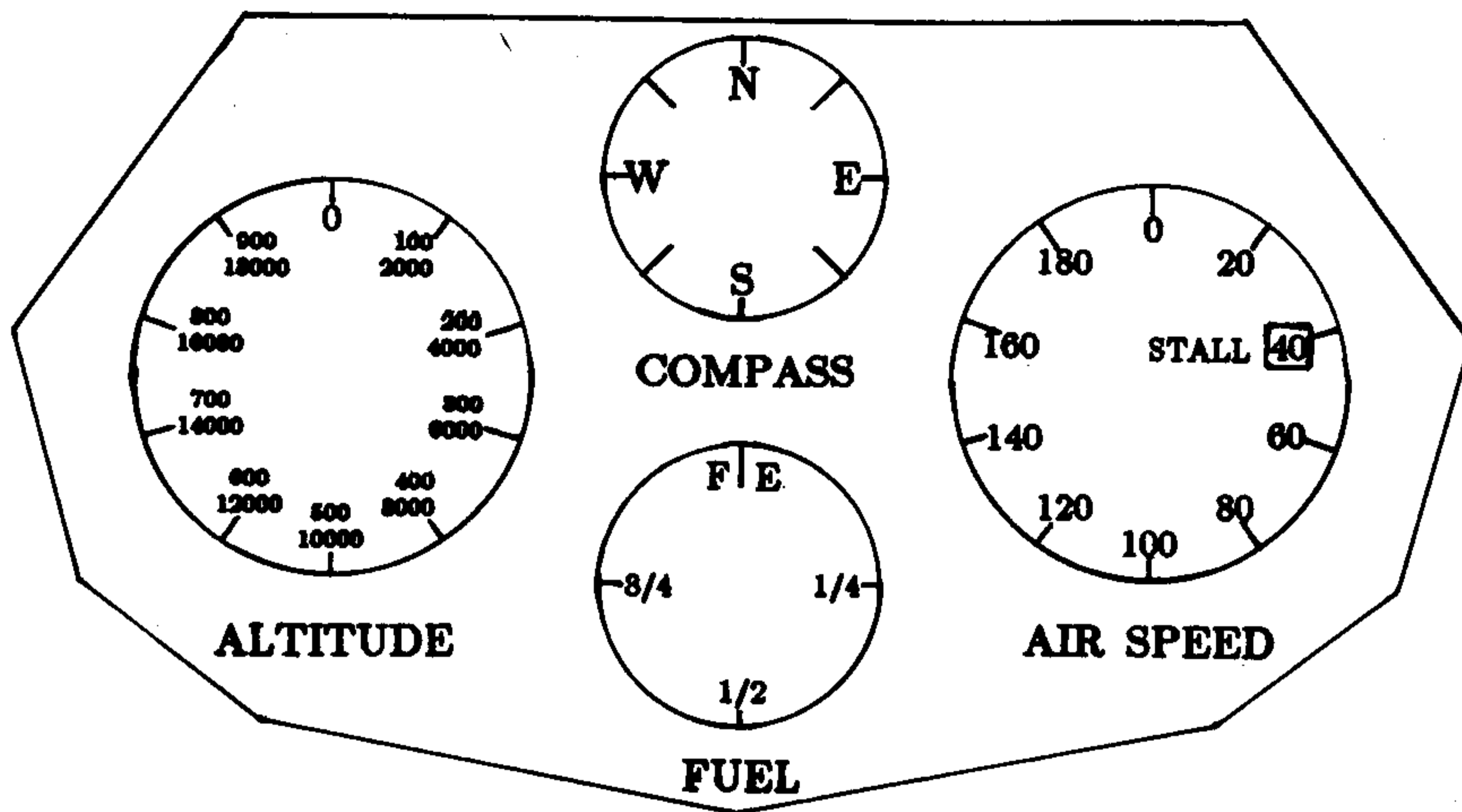

# SPAD XIII Keyboard Template

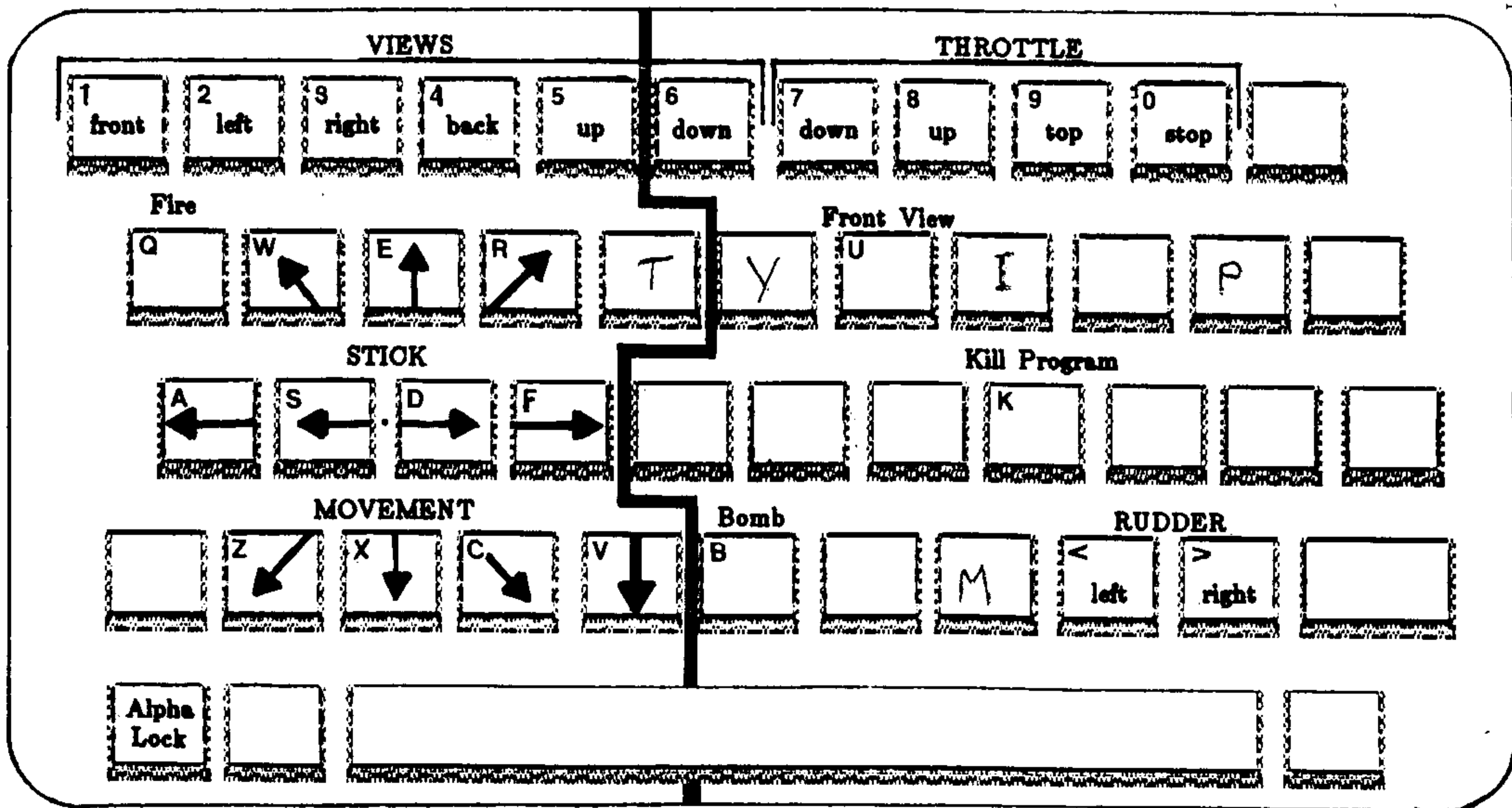

Alpha Lock key must be up to use Joystick 1

the approaching near end in your gunsight. Make sure that your wings are level. Pull back on the stick at fifty feet once to keep your airspeed less than 100 knots and your nose up. It isn't necessary to land precisely parallel to the airstrip since it's all level ground. You've landed when your altitude is zero and your nose rises abruptly. You must taxi to an area near the hangar and let your speed drop to zero. When you have done this the plane will be serviced, fuel, bombs, and ammunition replenished, and the plane will move to the starting point, facing due north.

Congratulations! You have completed your first flight.

## **7. Acrobatics**

### **a) Turns and Extreme turns**

Turning the Spad is not difficult to do if you just keep in mind that you will lose lift at a greater and greater rate the greater your degree of banking. At full throttle, you can turn 40 degrees (right or left stick x 5) without losing altitude, but turns of 45 degrees or more require you to pull back on the stick to stay level.

Extreme turns can be disastrous - you can lose control of the plane and go into a spinning dive. Don't use the **A** and **F** keys (hard left and right) unless you are an experienced pilot attempting a barrel roll or other acrobatic maneuver.

### **b) Climbing and Stalling**

The best way to climb is just to put the throttle up. If you pull back on the stick excessively, your angle of attack will increase and you will lose airspeed. The conditions for a stall are met when your airspeed goes below 40 knots. When you stall your plane will lose its lift catastrophically and will plunge down and sideways. Depending on the conditions, this plunge may or may not evolve into a vrille or wild downward spin. The best way to handle these out-of-control situations is to lower the throttle first and try to turn counter to the spin. If you pull up first, it will only make the situation worse.

High throttle wastes gas - the best policy is to climb to the altitude you want and lower the engine.

### **c) Barrel Roll**

A barrel roll is when you use your ailerons to roll the aircraft through 360 degrees. This is a relatively simple maneuver if you have your speed up. To do a barrel roll, top your throttle, put your nose down with the crosshairs well below the horizon, until your speed reaches 150 knots. Let your nose come up until the cloud line is below your guns. Push the **A** key for a left barrel roll and **F** for a right barrel and don't let up until you're level again.

### **d) Loops**

The simple loop is also fairly easy. Get to top throttle, push the stick forward until you reach 150 knots, and then press the **V** key until you've gone all the way around. For multiple loops, keep the **V** key down. Outside loops are impossible in a Spad due to the primitive engine.

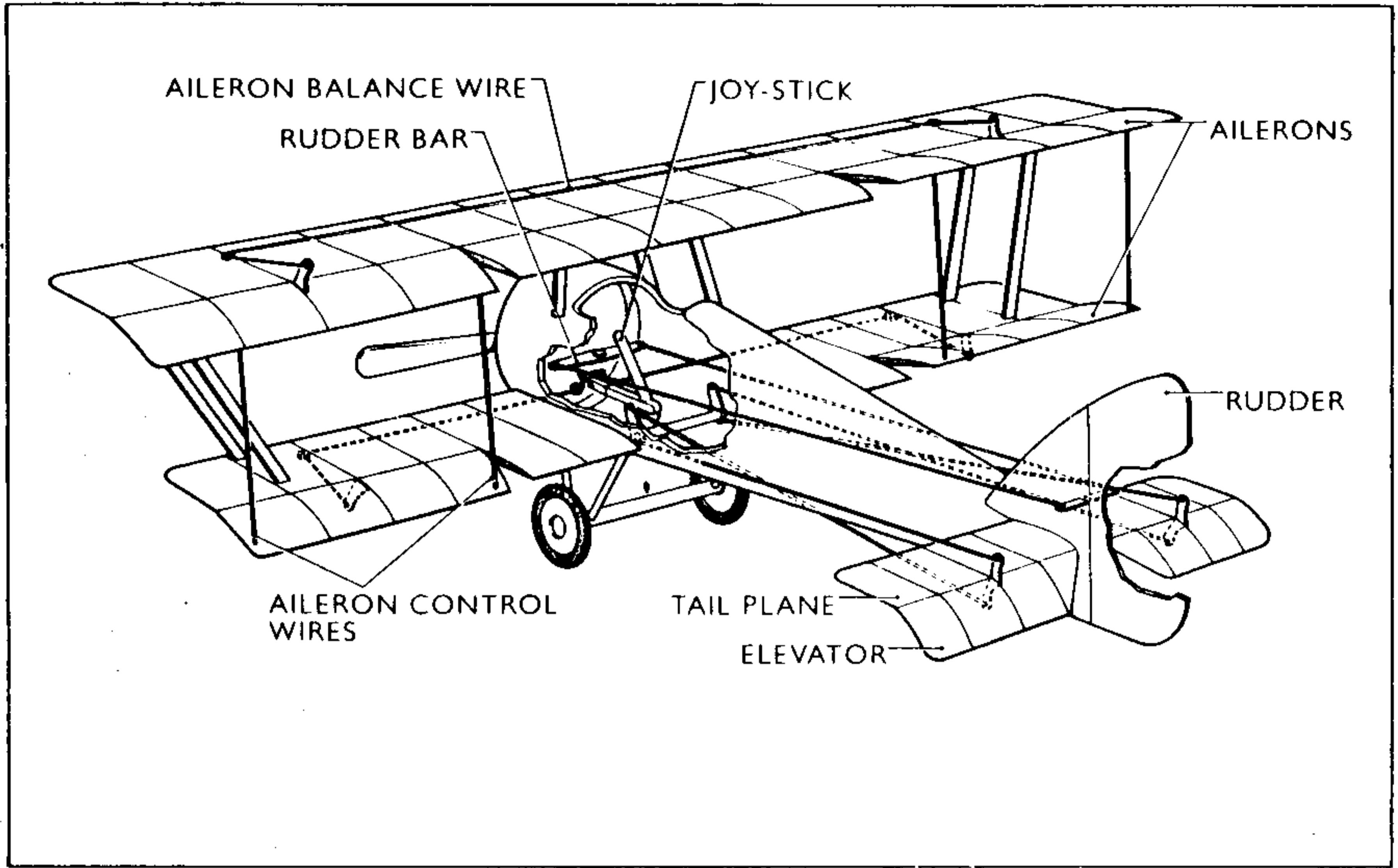

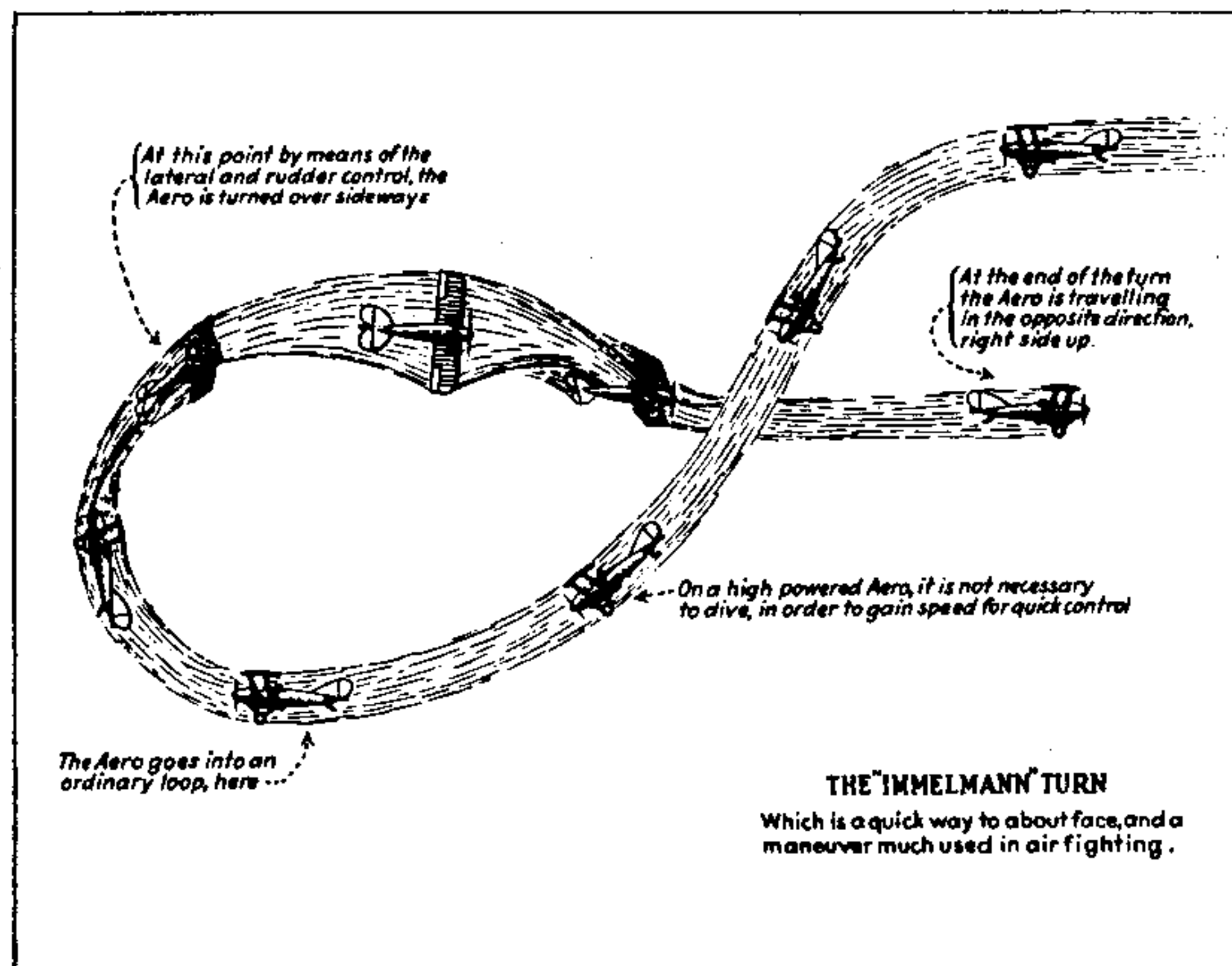

#### e) Immelmann turn and Split-S

The Immelmann turn, developed as a tactical maneuver for dogfights, involves making a half loop up followed by a half roll to return to level flight. At top throttle, push nose down until you're at 150 knots, press the **V** until you see the reversed horizon in front of you, hit hard aileron, and roll to upright position. If your nose is pointed down pull back on the stick slightly.

The Split-S is a half-roll followed by a downward half loop. Top the throttle, push the nose down to 150 knots, then let the nose rise until it's just above the horizon. Hit hard aileron (**A** or **F**) to get the half roll - wait a second when you are upside down and then pull back on the stick a few times.

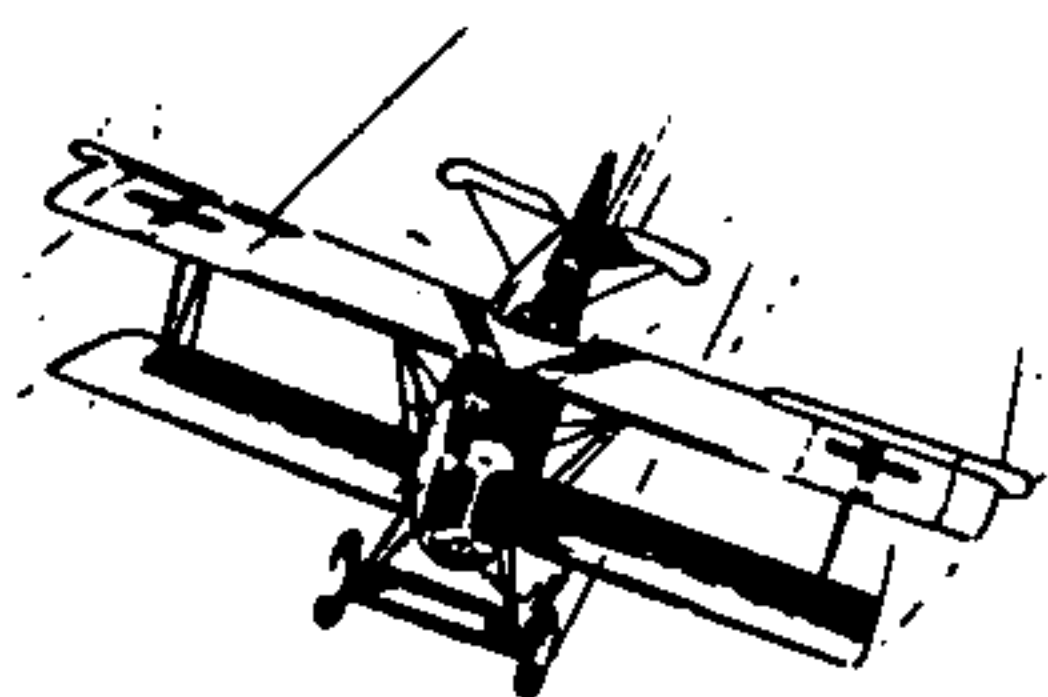

#### 8. Game

You are the pilot of a brand new Spad XIII, assigned to the 94th Squadron of the Air Service of the American Expeditionary Forces. Your airfield, located on the eastern outskirts of Paris, is a small strip of land with one hangar. It is the morning of a day in late Spring, 1918. The weather promises to be fine, but there is a high mist at 1000 feet. Already there are scattered cumulus at 3500 feet. The wind is from the west at 10 knots.

The plane is fully fueled and ready to go, carrying 5 bombs and 1000 rounds of ammunition for your machine guns (enough for 100 bursts). You plane is pointed north, the correct direction for take-off.

#### a) Enemies

The front lines of World War I are just 20 kilometers to the east. German two-seater observation planes (mostly Albatross CX's) can be anywhere in the combat zone (See Figure 3). These planes are slightly slower than the Spad, but their machine guns, though not as accurate as yours, can shoot in any direction. In addition, above the enemy lines there are 10 enemy observation balloons defended by flak batteries on the ground. Behind the German lines is a German airfield. It is recognizable by its two hangars and a plane on the ground. It too is protected by flak.

1) The two-seaters will, when attacked, either perform defensive circling maneuvers or try to get away. The circles can be large or small, and the smaller the circle, the harder it will be to get on the plane's tail. It may change the direction of its circle at any time. Since your aim is much more accurate than the Germans, it is best to shoot it at the greatest distance possible. You can't hit it, however, unless the plane is at least as big as your crosshairs. Try to get on the tail, if possible, as this will keep your motion small relative to the other plane, and you can fire at leisure. Rudders can be used for fine-tuning your position. When shooting at the side of the plane, if the plane is relatively large, you must aim at the engine to score a hit.

The chase can be a challenge. Remember, if the plane is above the horizon, that means he is at a greater altitude than you; and if he's below you, the plane will be below the horizon line. Determine the course the other plane is travelling, and aim ahead of him to cut him off. Attacking from below is uncertain, because of the possibility of stalling. The best way to turn sharply while tracking the plane is to do an Immelmann turn or a Split-S.

2) The observation balloons do not move. There are ten of them, between 500 and 1500 feet up, forming a straight line just behind the German trenches. If you go due east from your airfield, they will be there. Each one is protected by a flak battery, which hurls explosive projectiles into your path. The flak will appear as orange bursts moving past your plane when you are about a mile away from them. The flak is **dangerous!** Evasive maneuvers do not help when under flak attack, in fact they slow you down and make you more vulnerable.

The balloons are best attacked by finding the last one in the row and approaching it from the end. If you are adjacent to two balloons you will be flacked by them both, thus reducing your chances of survival. The less time you spend in the vicinity of the balloon, the less danger. Never attack a balloon with your nose up - try to increase your speed by lowering your throttle and attacking in a dive.

3) The enemy airfield, located due east and behind the line of balloons, is also protected by flak. Your principal mission, beyond destroying enemy planes, is to bomb the two hangars there. Dropping a bomb so that it hits a specific target is a fine art, and must be practiced. It's easiest to bomb at less than 500 feet, looking down with the **6** key. The bomb doesn't travel horizontally as much, the target is larger, and, since you can only drop one bomb at a time, you can drop another one sooner. Your altitude must be less than 1000 feet to see the explosion. It is possible to dive bomb, which again exposes you less to flak, but this takes long practice.

Occasionally, the hangars have been struck before you arrive there, by members of your own squadron. If so, they will already be on fire and you will be credited for destroying one of them. You receive no credit for shooting at the Fokker plane parked there.

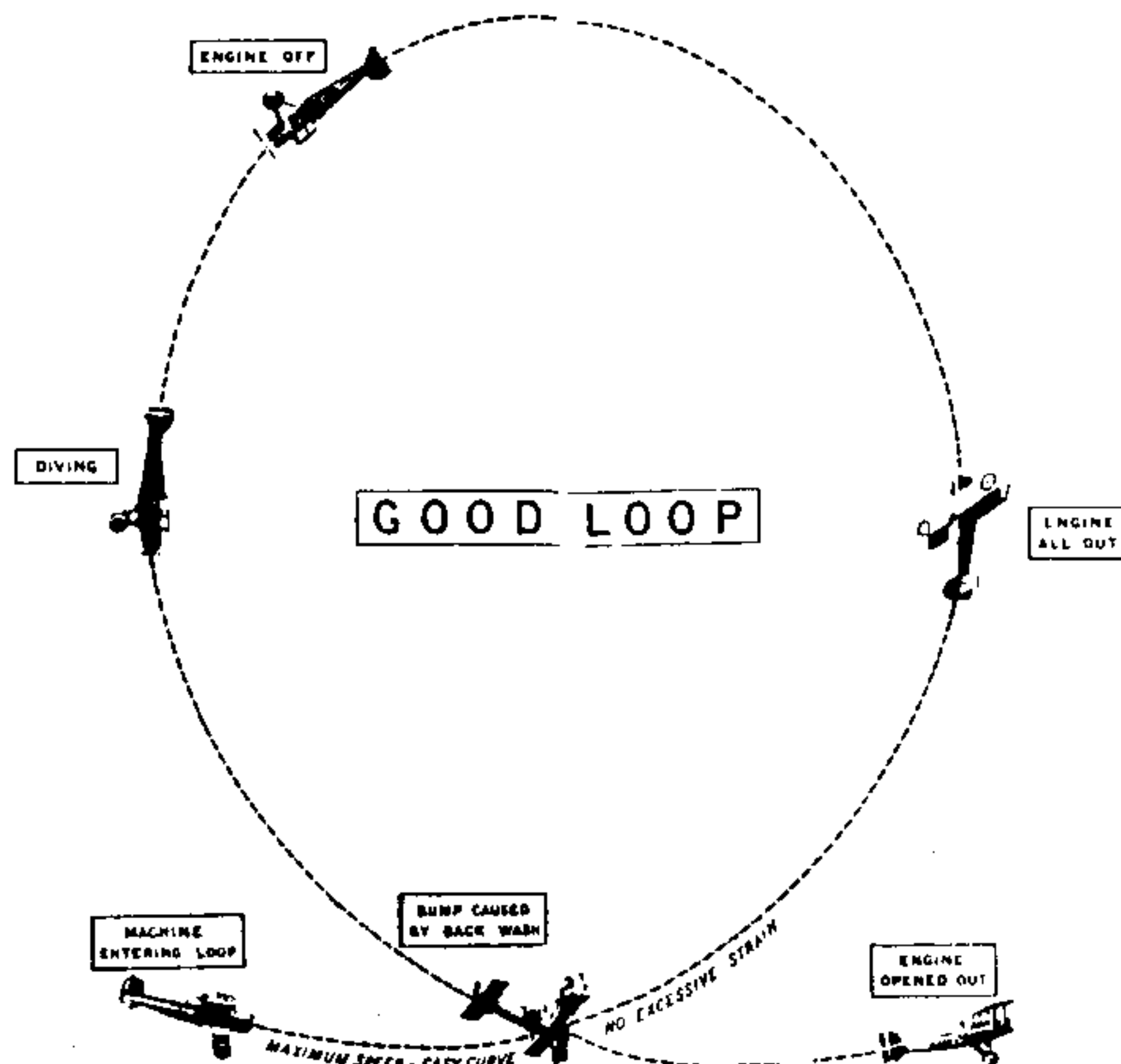

## b) Damage

Either the flak or the machine guns of the observation planes can damage the Spad. The damage can be light and affect the flight little, or be catastrophic. In most cases the only clue to the amount of damage your plane has suffered will be in how it flies. The least severe damage to the Spad will be destruction of the rudder control. This will simply mean that you can't use the rudder; however, the ailerons alone can manage any of the maneuvers you wish to make. The next level of damage is destruction of the elevator. You can still get home, since you can control your height with the throttle, but complicated maneuvers are difficult or impossible. If your engine is hit, it will sputter and lose power. Pressing the **9** key (top throttle) will goose the engine into giving a burst of power for a short time, but this must be done continuously to see any real effect. The Spad was not made to glide, but to escape capture you should try to make it back over the French lines. The worst damage you can suffer is to the ailerons. When the control line is severed, the ailerons will fall into a hard left bank. This is almost uncontrollable, although pressing the extreme right key (**F**) and pulling the stick back and to the right (**C**) can keep you level. The right rudder (**.**) helps also, as does powering down. Only the experienced pilot will be able to land with this handicap.

When more than one of these damages occur, it is very unlikely that the plane can safely land.

## c) Repairs

Landing near your hangar refuels and rearms your Spad, repairs damage you may have sustained, and lets the Germans repair their hangars if you have bombed them. This means that you have 0 altitude and 0 airspeed. If you are not close enough to your hangar you can taxi over to it. Your plane will reappear, pointing north, and ready to take off.

## d) End of Game

To end the game successfully you must 1) land undamaged anywhere and press the **K** key, 2) land damaged on French territory, or 3) land damaged on German territory and escape capture.

To end the game unsuccessfully, 1) crash, or, 2) land damaged on German territory and be captured. The screen will go blank except for **PRESS ENTER**, or possibly **CAPTURED**.

You only see the Final Score screen if you end the game successfully. At this time the number of enemy planes, observation balloons, and enemy hangars you have destroyed will be tallied. Only planes count when the awarding of Ace status is done, and you must have downed at least five of them to qualify.

To begin the simulator again, press **ENTER** from the Final Score screen or the blank screen. This will take you to the **TI Main Title Screen**. Hit the **2** key twice and it will autoloading.

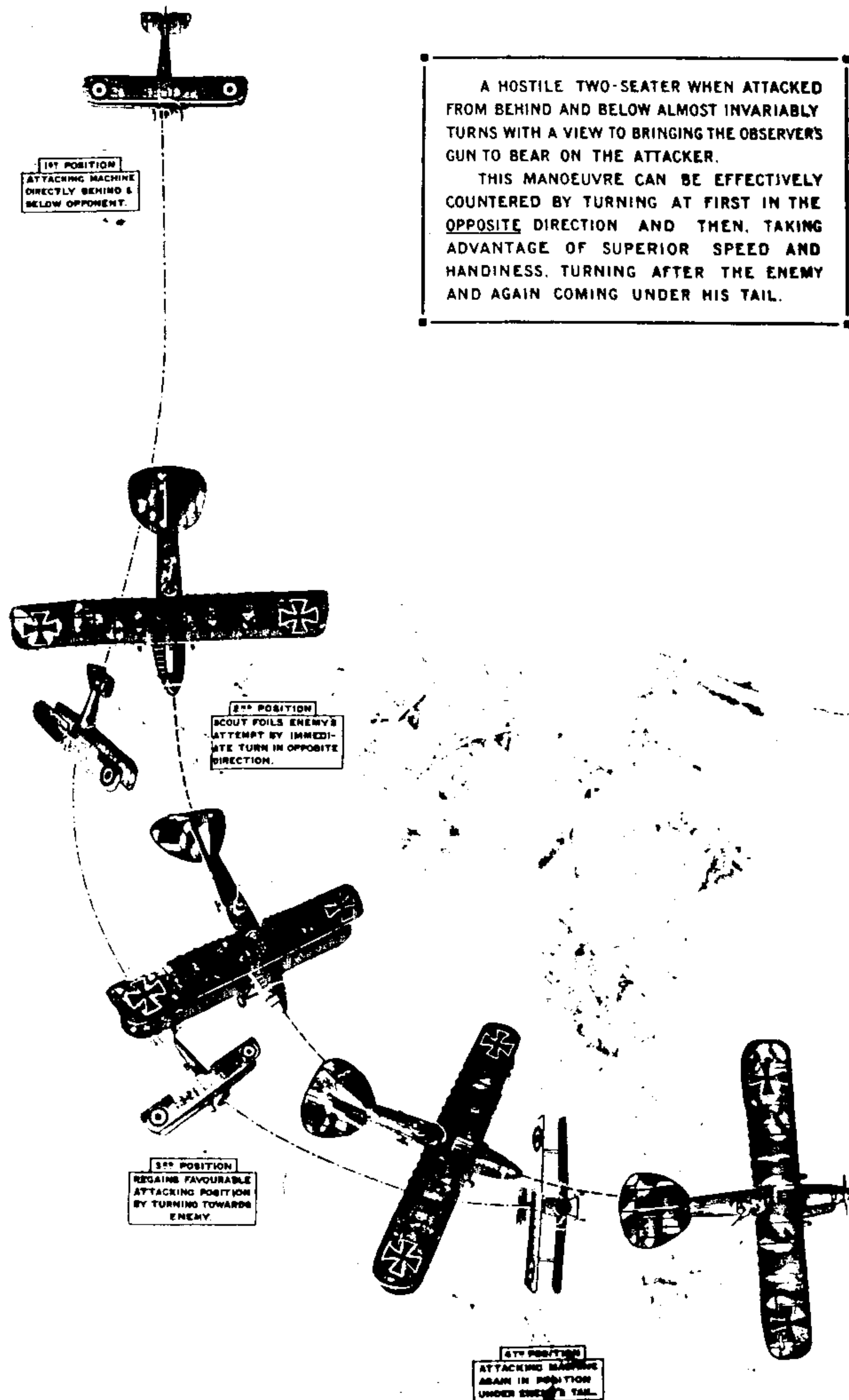

## 9. Scenarios

The following scenarios are in addition to your basic mission of destroying enemy planes, observation balloons, and enemy hangars.

### a) Assigination in Paris

You met an attractive Parisian at a party the weekend before. After a wild night, you promised this person that you would fly by the Eiffel Tower today and wave. Take off and fly due west for about twelve minutes, until you see the Seine, and then turn south. The tower should be visible shortly. Make a tight circle around the monument at about 500 feet, looking out the right side window. After two revolutions, head back for your airfield as quickly as possible so that you won't be missed.

### b) Observation

Because of damage sustained by the Observation Group, you have been assigned to do a reconnaissance of the trench positions along the front lines. Head north until you see a French village, then east until you are over the trenches. Turn parallel to the trenches. Using pen and paper, sketch the positions of the trenches until you see the destroyed village in no-man's-land. You can avoid or attack the observation balloons as you see fit. Return to your airfield and land.

### c) Breaking In a New Spad

To get a feel for the new Spad, do a series of acrobatic maneuvers. First climb to 3000 feet. Do an Immelmann turn followed immediately by a Split-S. Do ten loops without stopping. Do a Barrel Roll. Stall and recover at least twice.

### d) Rescue at Mareuil

You have received word that there is a spy who has an urgent message for your commander. He is stuck in Mareuil, behind German lines. Take off, and, being careful to conserve fuel, head northeast towards the Destroyed Village. Use the map to find the village as best you can. It may not be easy. Once you have located Mareuil, land on the main street. Take off again and return to your home airfield with the information.

### e) Big Adventure

You have been assigned to destroy the gun emplacements in the hills south of the Marne. The hills are due east, beyond the German airfield. As you fly over the front, strafe the eastern trenches with gunfire from an altitude of 300 feet. Continue east, and, when you reach them, bomb the German hangars. When you reach the hills, make several low flights over them, shooting all the while. Drop all your bombs as close to the center of the smallest hill as possible. If you want to take out a few observation balloons on the way home, do so, but be careful that you don't run out of fuel.

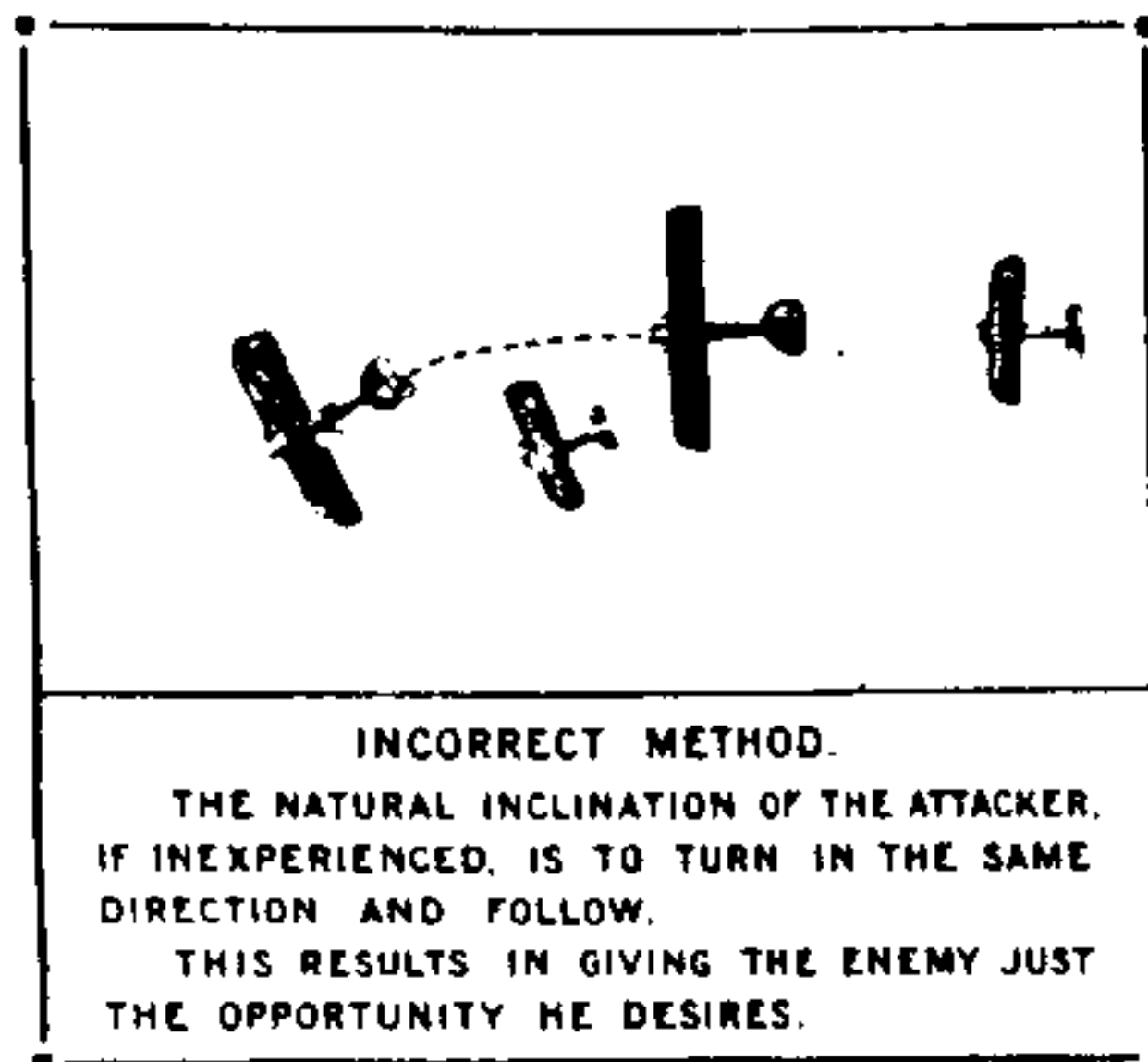

IN CASE OF ENGINE FAILURE  
 DON'T TURN BACK - PUT HER NOSE  
 DOWN AT ONCE AND MAKE SOME  
 SORT OF A LANDING AHEAD.

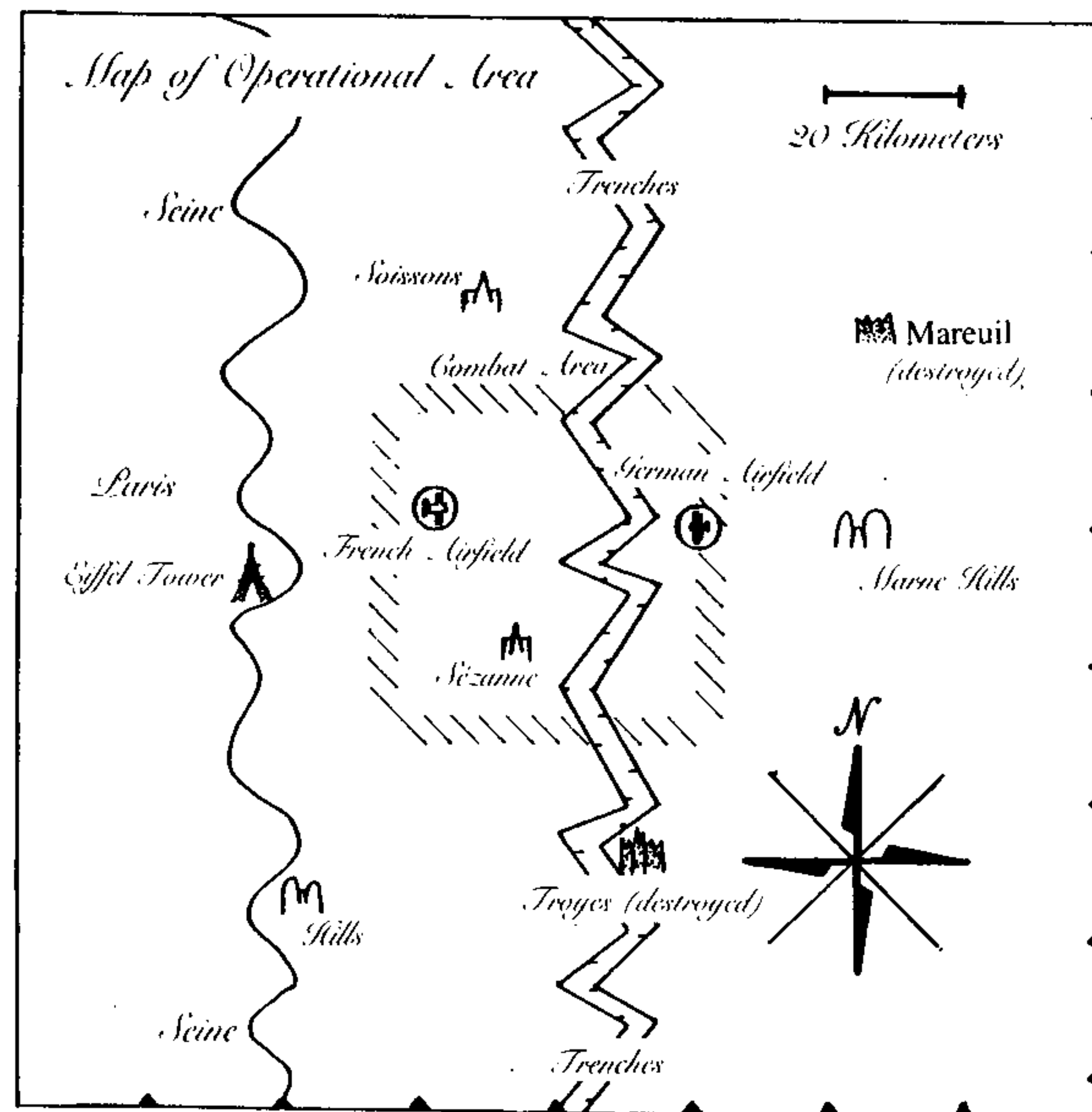
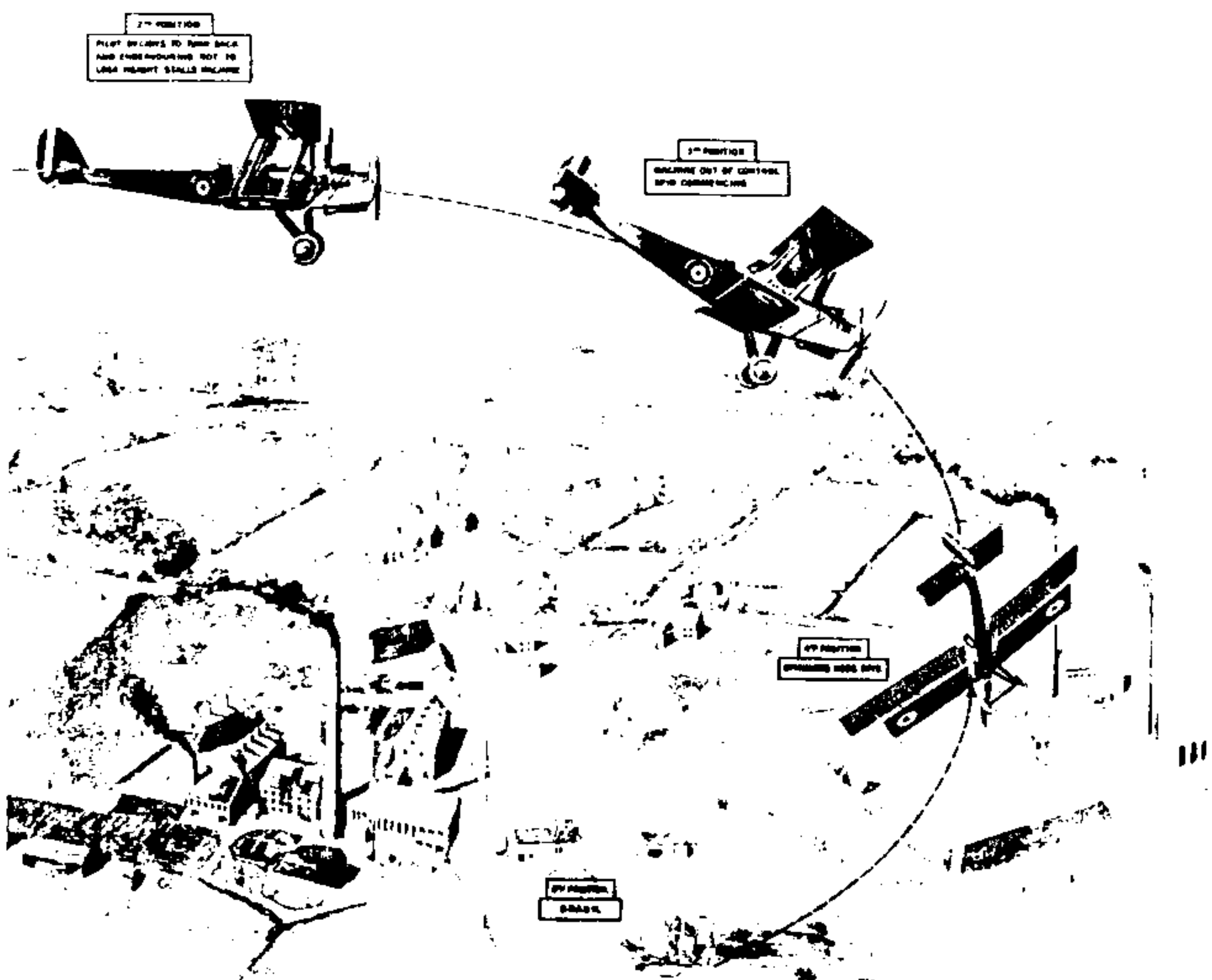

### Spad XIII Specifications

Nation — France  
 Manufacturer — S. P. A. D.  
 Engine — Hispano-Suiza 8BEc 8-cylinder liquid cooled in-line V (235 hp.)  
 Wingspan — 26' 11"      Length — 20' 8"  
 Weight — 1804 lbs. fully loaded      Maximum Speed — 139 m.p.h.  
 Ceiling — 21,800 ft.      Endurance - 2 hrs.  
 Armament — 2 fixed Vickers machine guns